

# Customer Adaptation Center

The Customer Adaptation Center (CAC) is the post production modification organization for Mack Truck's Lehigh Valley Operations. The CAC is housed in a 20,000 Sqft facility offering up to 1000 hours a day of capacity. The Customer Adaptation Center is a part of the Mack Trucks family which provides exclusive access to resources and provides unique ways of working in support of our customers.

- This includes documentation of modifications allows for efficient aftermarket support
- The current product offerings consist of customer adaptations that are not available through the standard production process due to volume, complexity or industrialization constraints.
- Standard product offers with full design and documentation fall within conventional warranty and support.
- The current product offering also supports local or customer supplied installations.

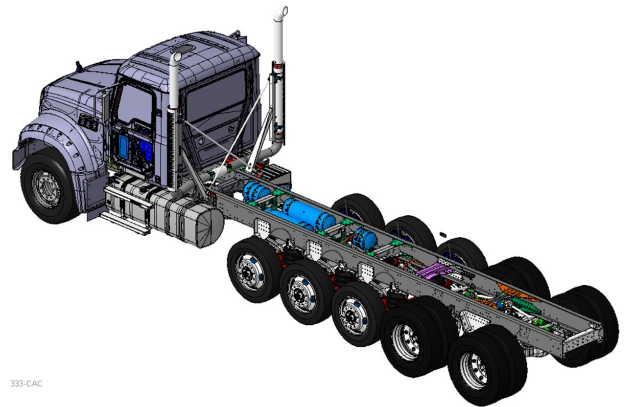

The Customer Adaptation Center has a dedicated engineering and design team to support our customer's needs. Our seasoned engineers bring extensive industry experience to develop innovated designs and concepts to meet customers demands. Product reviews and layouts are performed to assure quality, form and fit. Our Customer Adaptation team can make modifications internally to the Mack Engineering System prior to production to improve quality, enhancement throughput and reduce costs



Click here to see the CAC Product Offering in the Tools section of the Mack Body Builder Portal or email us at

[Support.customeradaptationcenters@macktrucks.com](mailto:Support.customeradaptationcenters@macktrucks.com)

# Mack Trucks Customer Adaptation Center

## **Auxiliary Axles**

**The CAC offers Vocation, Highway, and Cab Over auxiliary axle installation**

- 13k and 20k Pusher
- 13k and 20k Tag
- Single to Triple Axle
- Product reviews and **layouts** are performed to **assure quality, form and fit.**
- Frame drilling and component relocation available prior to production build

## **Chassis and Drive Modifications**

- Auto Chassis Lube System
- Pintle Hook Installation
- Wheelbase Modifications
- Telma Induction Braking System
- Mack Sales Tool Published Offering Gap Fulfillment.

## **Electrical, Power, and Safety Systems**

- Phillips and Temro Idle Free E APU Series 1000 or Series 5000
- Thermoking Tripac Envidia APU
- PTO Installation
- Blower Installation
- Preco Blind Spot Monitoring
- Granite Bendix Blindspotter
- Lytx Drive Cam
- 3rd Eye Camera Systems
- Safety Vision Camera Systems
- Peoplenet/QualComm installation

## **Body Builder & Dealer Preparations**

- Wetline Kit Installations
- PDI/DOT
- Body Builder Frame Rail Mounting Plate Installation and Controls
- Programming Changes and Updates
- Geo Tab Installation

## **Driver Support and Accessories**

- Flaps, Fenders, Fender Guide installation
- Headache Rack, Deer Guard, Brush Guard, Toolbox installation
- Decal and Fairing Installation
- Auxiliary Lighting

# Product Information



## MACK TRUCKS CUSTOMER ADAPTATION CENTER

Updated: October 15, 2020

<b>Introduction</b> .....	2
<b>Products and Offerings</b> .....	3
Pre-delivery Inspection (PDI).....	3
DOT Inspection.....	3
Decal Installation .....	3
Tire Management Systems.....	4
Aperia Technologies Halo Automatic Tire Inflation System .....	4
Bendix SmarTire™ Tire Pressure Monitoring System.....	5
Collision Avoidance Systems.....	6
Bendix BlindSpotter® Side-object Detection System .....	6
Auxiliary Power Units.....	8
Vehicle Compatibility Requirements and Recommendations.....	8
Idle Free eAPU Series 1000.....	9
Idle Free eAPU Series 5000.....	10
Thermo King TriPac Envidia Electric APU .....	11
Headache Racks .....	13
Sturdy Lite 6880 Sleeper 2 Chain Hangers, 2 Half Trays .....	13
Sturdy Lite 6880 Sleeper 2 Chain Hangers, 2 Half Trays, with Bar Window.....	13
Bumper Guards and Brush Guards .....	14
Mack Anthem Bumper Guard .....	14
Mack Anthem Brush Guard .....	14

## MACK TRUCKS CUSTOMER ADAPTATION CENTER

**Updated:** October 15, 2020

---

### Introduction

The Mack Trucks Customer Adaptation Center (CAC) is a 22-stall, 20,000 square foot extension of the Lehigh Valley Operations Plant and is staffed with a dedicated engineering staff, factory trained technicians who specialize in building customized Mack trucks, along with internal purchasing and accounting teams, all providing exclusive access to resources and unique ways of working to support our customers.

The CAC provides up to 1000 hours of capacity a day, offering dealers and customers services and products that delivers a truck that's ready to go directly into service!

CAC services and product offerings will be introduced in multiple phases to ensure reliable integration with the Mack Sales System (MSS). This product information bulletin will be updated as new services and product offerings become available.



Documentation of modifications allows for efficient aftermarket support and all CAC work carries a full warranty.

For dealer inquiries, please contact CAC staff at: [support.customeradaptationcenters@macktrucks.com](mailto:support.customeradaptationcenters@macktrucks.com)

# Product Information



## MACK TRUCKS CUSTOMER ADAPTATION CENTER

Updated: October 15, 2020

### Products and Offerings

#### Pre-delivery Inspection (PDI)

Sales Code: MBI0001

A factory-trained technician ensures the truck is ready for service by performing a thorough PDI. Out process is to inspect, make adjustments, tighten, adjust, or add fluids for all components. This includes verification of software, routing and clearance of harnesses and hoses, fluid levels, electrical connections, torque requirements, functionality of operations, and a complete road test.

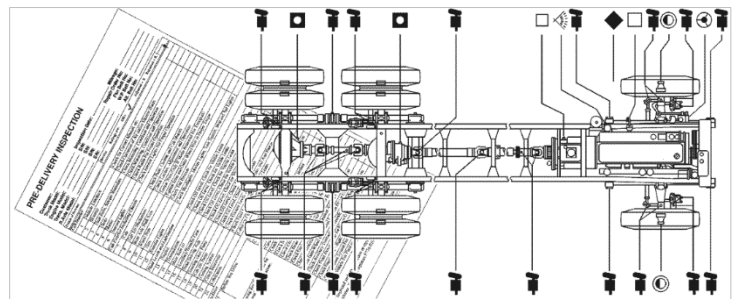

#### DOT Inspection

Sales Code: MBK0001

Our DOT inspection is performed by factory-trained technicians to ensure the vehicle meets all requirements set forth by Federal Motor Carrier Safety Administration (FMCSA) 49 CFR Part 396.



#### Decal Installation

Sales Code	Service Description	Decal Quantity
MBO0001	Customer Supplied Cab Decals	1
MBO0002	Customer Supplied Cab Decals	2
MBO0003	Customer Supplied Cab Decals	4
MBO0004	Customer Supplied Cab Decals	6
MBO0005	Customer Supplied Cab Decals	8
MBO0006	Customer Supplied Cab Decals	10

Installation of customer supplied decals. Select the number of decals to be installed on the vehicle. After choosing the appropriate amount of decals, email [support.customeradaptationcenters@macktrucks.com](mailto:support.customeradaptationcenters@macktrucks.com) to confirm decal layout, details, and shipping instructions. Please note that truck options like passenger door peep window could impact location and installation of decals.



## MACK TRUCKS CUSTOMER ADAPTATION CENTER

Updated: October 15, 2020

### Tire Management Systems

#### Aperia Technologies Halo Automatic Tire Inflation System



Sales Code	Product Description	Axle Position
MBM0001	APERIA HALO TIRE INFLATORS	1 Steer, 1 Drive
MBM0002	APERIA HALO TIRE INFLATORS	1 Steer, 2 Drive
MBM0003	APERIA HALO TIRE INFLATORS	1 Steer, 1 Aux, 1 Drive
MBM0004	APERIA HALO TIRE INFLATORS	1 Steer, 1 Aux, 2 Drive
MBM0005	APERIA HALO TIRE INFLATORS	1 Drive Only
MBM0006	APERIA HALO TIRE INFLATORS	2 Drive Only
MBM0007	APERIA HALO TIRE INFLATORS	1 Auxiliary, 1 Drive
MBM0008	APERIA HALO TIRE INFLATORS	1 Auxiliary, 2 Drive
MBM0009	APERIA HALO TIRE INFLATORS	2 Auxiliary, 2 Drive
MBM0010	APERIA HALO TIRE INFLATORS	3 Drive Only

The Halo automatic tire inflation system is a tire inflation device for tractors that attaches directly to the wheel hub. The Halo operates similar to a self-winding watch or hub-odometer by using the rotational motion of the wheel to generate air pumping power. There's also a smart pressure regulator that monitors a tire to ensure it is constantly inflated to the target pressure.

The compact, self-contained design is built to withstand even the toughest conditions out on the road, making it practically maintenance-free. Available for dual and wide-base tires, Halo is designed to improve fuel economy and road safety while reducing tire expenditures, downtime, and maintenance costs for commercial fleets.

#### Aperia Fleet Case Study

Tire pressure intentionally lowered at start of test for trucks equipped with Halo

- 10 Halo-equipped tractors
- 1,000,000+ miles driven
- 12 month test duration

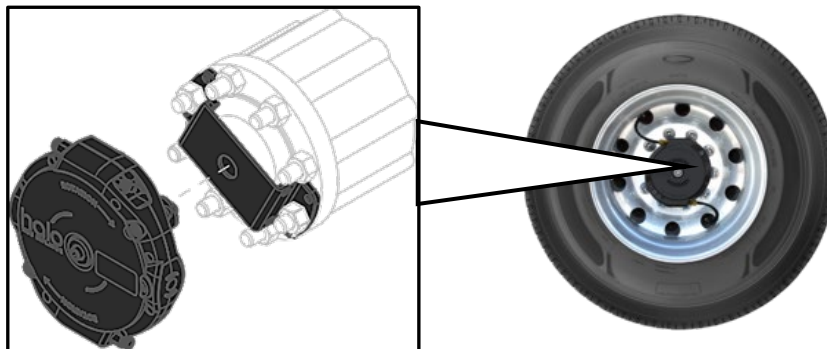
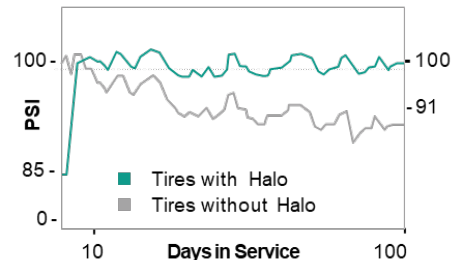

# Product Information



## MACK TRUCKS CUSTOMER ADAPTATION CENTER

Updated: October 15, 2020

### Bendix SmarTire™ Tire Pressure Monitoring System



Sales Code	Product Description	Axle Configuration
MBN0001	Bendix Tire Pressure Monitoring System	4X2
MBN0002	Bendix Tire Pressure Monitoring System	6X4
MBN0003	Bendix Tire Pressure Monitoring System	6X2
MBN0004	Bendix Tire Pressure Monitoring System	8X4
MBN0005	Bendix Tire Pressure Monitoring System	10X4
MBN0006	Bendix Tire Pressure Monitoring System	8X6

The SmarTire™ Tire Pressure Monitoring System from Bendix is a simple way to help drivers and maintenance departments know what's happening with the tires on the truck. Tire pressure and temperature status is shown on a dash display, informing the driver if there's a tire problem on the road and mechanics can check the same information on a hand-held reader.

#### Bendix SmarTire™ delivers:

- Real-time low pressure and high temperature warnings
- Provides early warning of pressure loss and increasing tire heat
- Flexibility that works with all wheel and tire types
- No need for special wheel or valve stem installations
- Robust, weatherproof components road tested in the harshest environmental conditions.

#### How Bendix SmarTire™ works:

The Bendix SmarTire™ system uses wheel-mounted sensors plus a wireless receiver to read and send both tire pressure and temperature information to an in-cab display. The system will alert the driver when the tire pressure gets too low, or the temperature gets too high.

Bendix publishes the following data:

- Improper tire inflation increases total tire-related costs by \$600-\$800 annually. A 20% under-inflated tire can attribute to the following:
  - ≈ 2% lower fuel mileage
  - ≈ 30% shorter tire life
  - ≈ 25% shorter tread life
- Average cost of a tire failure ≈ \$800/incident

#### But checking tires can also be expensive

- Check tires on a tractor ≈ 30 minutes
- Hours per year for each tractor ≈ 42 hours
- Average hourly rate of technician ≈ \$60
- Cost to check tires annually/tractor-trailer ≈ \$2,500

*With just the labor savings alone, SmarTire™ can pay for itself in just eight months!*

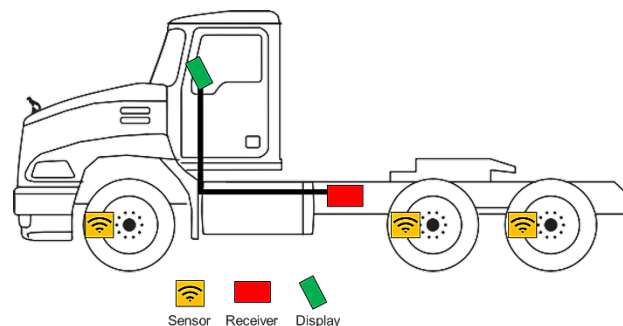

## MACK TRUCKS CUSTOMER ADAPTATION CENTER

Updated: October 15, 2020

### Collision Avoidance Systems

#### **Bendix BlindSpotter® Side-object Detection System**



Sales Code: MBK0001

The Bendix BlindSpotter® Side Object Detection System (rev. 2) is an aid to help drivers with vehicle blind spots by alerting them to large metallic objects within the range of the radar sensor mounted on the side of the vehicle. The Bendix BlindSpotter® rev. 2 system includes a radar that is an improved direct replacement of the first generation system. The BlindSpotter® rev. 2 radar has the same fit and form as that of the original BlindSpotter® radar, except for the addition of the Controller Area Network harness. It is fully backward compatible with the BlindSpotter® mounting scheme and the Operator Display Unit. Used in conjunction with mirrors and other instrumentation to maintain safe operation of the vehicle, the radar sensor(s) provide up to a ten foot by forty foot detection zone.

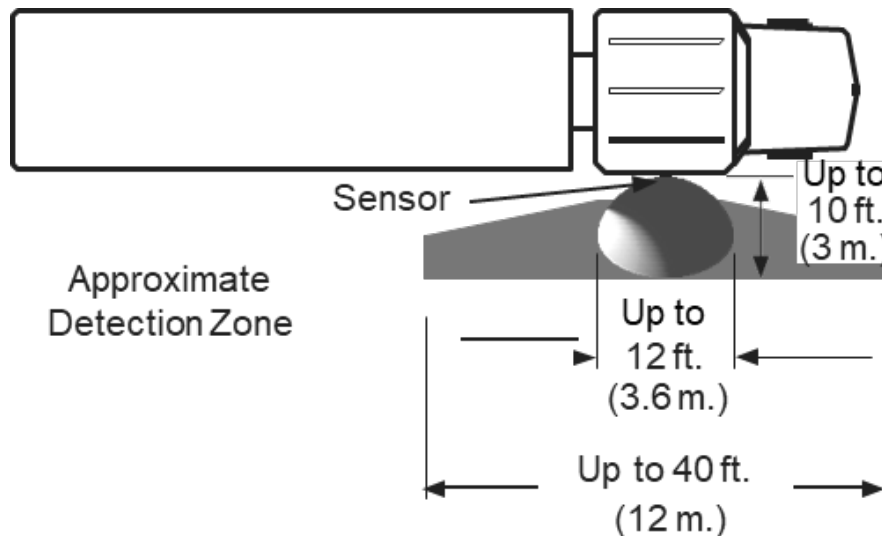

**System Operation:** The Bendix BlindSpotter® rev. 2 radar system assists the driver by giving audible and visual alerts

- **A visual warning:** The side object display unit uses two LED indicators to display the status of the side radar sensor. The yellow LED indicates the system is active, but no objects are detected. The red LED indicates the system is detecting an object.
- **An audible warning:** When the vehicle's turn signal is active and the sensor detects a large metallic object alongside the vehicle, the side sensor display emits an audible warning tone.



## MACK TRUCKS CUSTOMER ADAPTATION CENTER

Updated: October 15, 2020

### Bendix BlindSpotter® operation continued:

- Volume Control:** This steps the volume level of the alerts between low, medium, and high (and back through the sequence). The most recent selection is stored in the memory.
- An Ambient Light Detector:** This automatically adjusts the brightness of the LEDs.

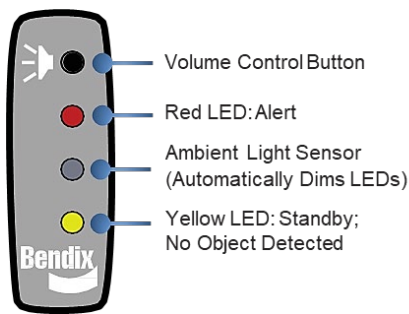

LED	Indication
Red	Object Detected
Yellow	No Object Detected
Red and Yellow (at power-up)	Self-Test
Red and Yellow (constant)	Active Sensor Fault

---

## MACK TRUCKS CUSTOMER ADAPTATION CENTER

Updated: October 15, 2020

---

### Auxiliary Power Units

#### *Vehicle Compatibility Requirements and Recommendations*

The following requirements and recommendations apply to all vehicles equipped with an APU.

#### Requirements:

1. Vehicle must be equipped with shore power and bunk outlets.
  - **Option 1: C320004** - 120V SHORE POWER W/O INVERTER, W/ RECEPTACLES IN SLEEPER
  - **Option 2: C320006** - 120V/1800W INVERTER MOUNTED IN SLEEPER STORAGE COMPARTMENT, W/SHORE POWER
2. Minimum 270 amp alternator.
3. Dealer must ensure adequate frame space is available for mounting APU. All APU dimensions are listed below. Open frame space is shown in PAWS top-view illustrations.

#### Recommendations:

A voltage inverter is recommended when using multiple appliances.

- **120IN18** - 120V AC INVERTER, 1.8 KILOWATTS (1800 WATTS)

# Product Information



## MACK TRUCKS CUSTOMER ADAPTATION CENTER

Updated: October 15, 2020

### Idle Free eAPU Series 1000



Sales Code: MBL0001

This system includes frame-mounted APU and battery unit and sleeper-mounted air conditioning and heater.

<b>Dimensions</b>	L 30.85" x W 20.24" x H 26.7"
<b>Required frame rail clearance</b>	24"
<b>12 volt DC to 120 volt AC Inverter</b>	1500 Watts, pure sine wave inverter
<b>Batteries</b>	4 AGM
<b>Air Conditioning</b>	Standard; 7500 BTUs
<b>Heat</b>	Standard: 17,000 BTUs
<b>Power Converter / Battery Charger</b>	Standard
<b>Shore Power</b>	Standard
<b>Reefer Link</b>	Optional



**Control Panel:** Located in the sleeper, the control panel allows the driver to turn the APU ON and OFF, adjust the fan speed and the air temperature. There are three performance lights and two warning lights on the control panel.

All duct work is incorporated into the cabinetry of the sleeper.



## MACK TRUCKS CUSTOMER ADAPTATION CENTER

Updated: October 15, 2020

### Idle Free eAPU Series 5000



Sales Code: MBL0002

Mounted on back of cab. The Idle Free Series 5000 is an innovative electric APU that offers ultimate cooling capacity, along with Automatic Start-Stop technology, to provide uninterrupted comfort during mandatory driver rest periods.

This new APU was designed to keep drivers cool in high ambient temperatures, so they are well rested and can perform to the highest safety standards.



#### Specifications:

- 10,000 BTU compressor
- 300+ cfm evaporator fan
- 439lbs with battery box
- Use with Cab Power® system for hotel loads
- Condenser dimensions (L x W x H)  
28.4" x 9.3" x 25.3"
- Evaporator dimensions (L x W x H)  
22" x 6" x 15.5"

#### Features:

- Unlimited run time with Automatic Start-Stop
- Two-year warranty
- 3-speed evaporator fan
- Direct airflow to sleeper (no duct work) to maximize efficiency
- Washable evaporator filter
- Multi-directional vents
- Runs on 4 deep cycle AGM batteries

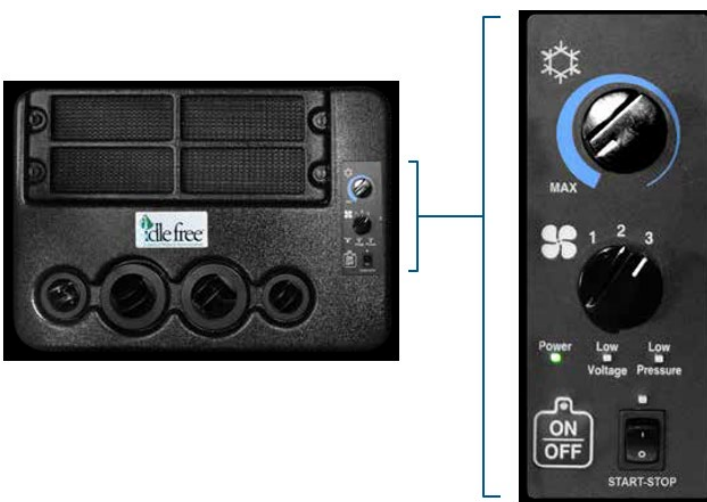

**Control Panel:** Located on the evaporator, the control panel allows the driver to turn the APU ON/OFF, adjust the fan speed and the air temperature. There are three performance lights and two warning lights on the control panel.

**Automatic Start-Stop:** The ON/OFF switch for the Automatic Start-Stop feature is located on the control panel. Turning this switch ON allows the truck to automatically idle to charge the batteries, turning the engine off once the batteries are fully charged. Automatic Start-Stop provides reliable, uninterrupted rest time for drivers and no delay on battery recharges.

# Product Information



## MACK TRUCKS CUSTOMER ADAPTATION CENTER

Updated: October 15, 2020

### Thermo King TriPac Envidia Electric APU

Sales Code: MBL0003



Thermo King's patented battery charging technology ensures proper charging and discharging of the APU and tractor batteries, extending overall battery life.

The NXT battery is engineered for optimum performance with TriPac Envidia

- Designed to maximize performance and increase runtime
- Dry cell technology for greater efficiency, longer life and a lower life cycle cost



#### Specifications:

- Air conditioning capacity:
  - BTUs / hr: 8,000
  - Watts: 2,342
- Heating capacity:
  - BTUs / hr: 7,500 (13,600 optional)
  - Watts: 2,200 (3,986 optional)

#### Features:

- System weight:
  - Battery box with cables: 480 lbs
  - Evaporator: 66 lbs
  - Condenser with drier: 26 lbs
- Evaporator airflow: 230 ft<sup>3</sup> / min
- Refrigerant: HFC R-134a

**Controls:** The TriPac HMI Controller features a simple three-knob design for easy operation.



Updated: October 15, 2020

### Thermo King TriPac Envidia Electric APU continued

#### Component Dimensions

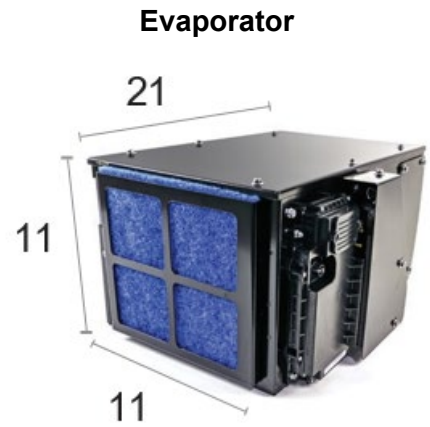
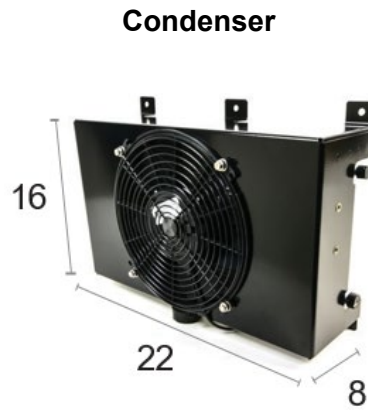



# Product Information



## MACK TRUCKS CUSTOMER ADAPTATION CENTER

Updated: October 15, 2020

### Headache Racks

#### *Sturdy Lite 6880 Sleeper 2 Chain Hangers, 2 Half Trays*



Sales Code: MBR0001

- 68" H x 80" W
- 2 Chain Hangers
- 2 Half-Trays
- Model available on sleeper cabs only



#### *Sturdy Lite 6880 Sleeper 2 Chain Hangers, 2 Half Trays, with Bar Window*

Sales Code: MBR0002

- 68" H x 80" W
- 2 Chain Hangers
- 2 Half-Trays
- Window 18" W x 24" H
- Model available on daycabs only



# Product Information



## MACK TRUCKS CUSTOMER ADAPTATION CENTER

Updated: October 15, 2020

### Bumper Guards and Brush Guards



#### *Mack Anthem Bumper Guard*

Sales Code: MBQ0001

Magnum Trailers Model: 17243

Weight: 110 lbs

**Features:**

- Radar Compatible
- Factory Tow Mounts
- Cam Lock Opening
- Light Weight High Strength Aluminum



#### *Mack Anthem Brush Guard*

Sales Code: MBQ0002

Magnum Trailers Model: 17244

Weight: 170 lbs

**Features:**

- Radar Compatible
- Factory Tow Mounts
- Cam Lock Opening
- Light Weight High Strength Aluminum

