

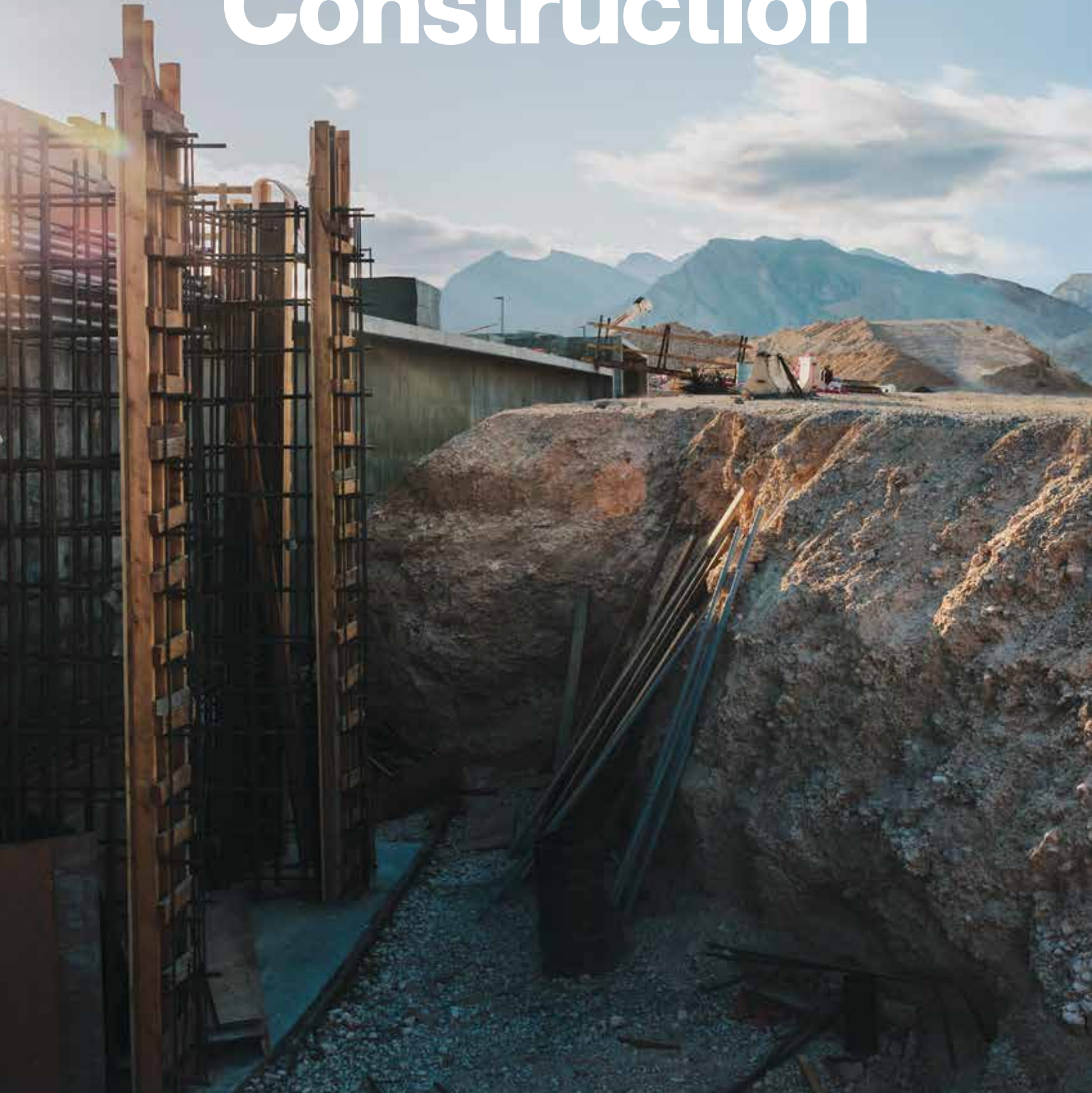

Construction





**OUT HERE,
TRUCKS
ARE BORN.
AND LEGENDS
MADE.**

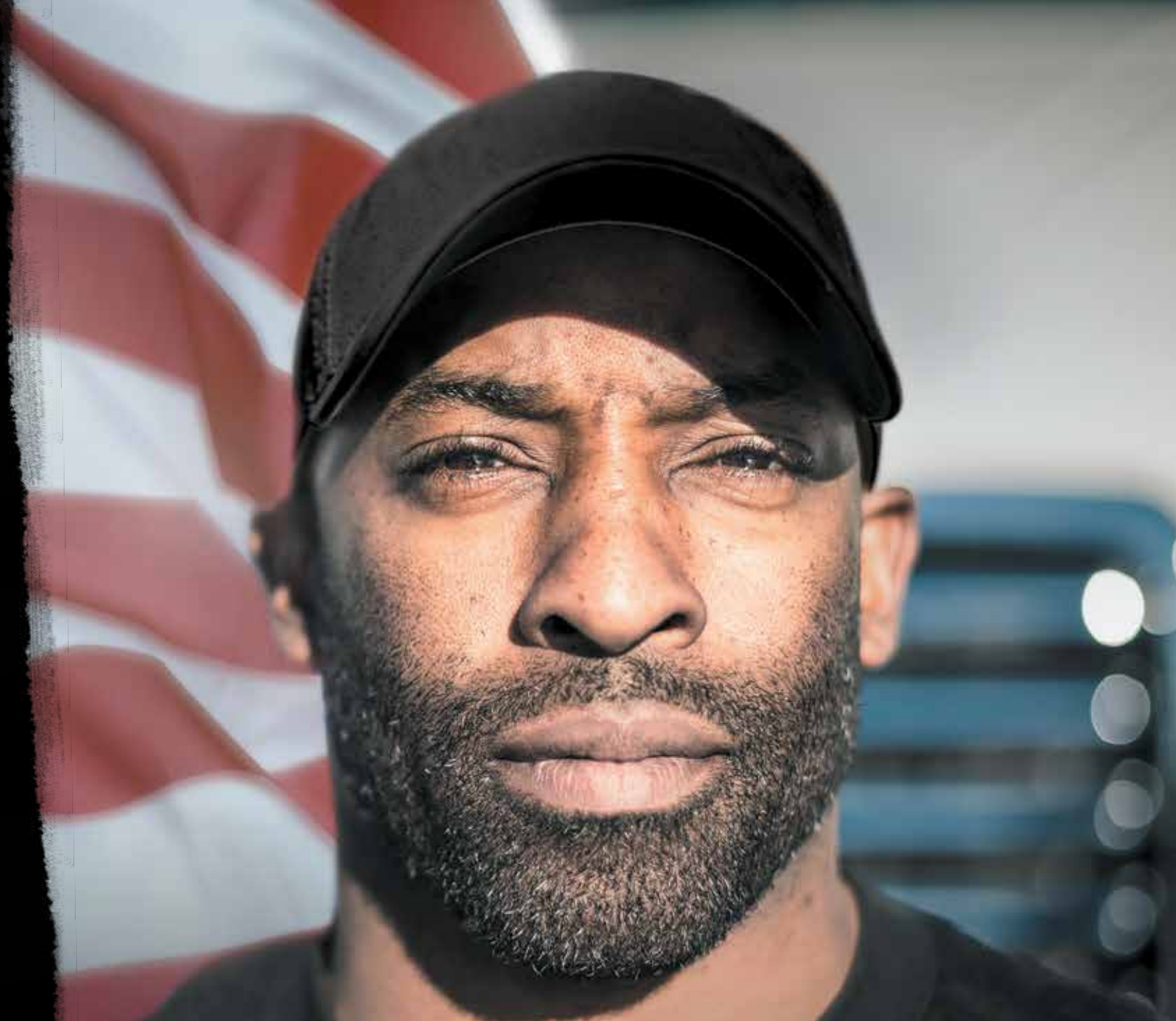

IN CONSTRUCTION, IT'S ALL OR NOTHING.

Constructed with purpose. Prepared for anything. Mack® trucks are designed to match the demands of your most severe sites. Because we didn't just build America, we built a reputation as the leaders in construction.



Concrete Pump

Kick mediocrity to the curb. These trucks come equipped with both the power and precision to successfully complete any concrete job.



Dump

Welcome complete control. Our highly customizable dump trucks put you in the driver's seat to tackle each day on your terms.



Mixer

Push productivity forward. These lightweight trucks move more without sacrificing durability.



Service/Utility

Combine power and the right-sized components, and you have the strength to handle heavy-duty jobs.



Severe Duty

Rest is for the weak. From start to finish, these trucks are prepared to deliver no-compromise performance for the heaviest of your heavy hauls.



Tractor

Any site, any time. Mack tractors are ready to tackle mean streets or no streets.

Granite®



TerraPro®



WE BUILD THE TRUCKS THAT BUILD EVERYTHING ELSE.

These are the leaders of the construction world. The team of trucks that have defined the industry for generations—and continue to push it forward. Engineered with renowned Mack reliability, we deliver the durable, modern-day machines that allow you to deliver on the jobsite.

Pinnacle™



Granite® MHD



Granite[®]

Mack[®] Granite is the unyielding foundation on any jobsite. One of the most popular and proven trucks on the road, Granite has the strength to get the job done right and the comfort to keep drivers powering through.

MP[®] engines

The 11-liter MP[®]7 and 13-liter MP[®]8 top out at 425 and 505 HP respectively, giving you the muscle to shoulder heavy loads.

mDRIVE[™] HD

Mack's mDRIVE HD comes standard on all Mack Granite trucks. The heavy-duty automated manual transmission is available with special low-gear ratios—including the standard 13-speed and available 14-speed version—and multi-speed reverse gears to fit any job, including specialized concrete applications.

Cornerstone[™] chassis

The Cornerstone frame system gives you the versatility to choose the right thickness and strength for your demanding applications.

Optimized driveline angle

Mack's top-mounted rear axle carriers ensure an optimized driveline angle for longer component life and a smoother operation.

Built for your application

Granite delivers across the board. This truck can be optimized to crush any job.

Unimax[®] axles

These maintenance-free axles give drivers exceptional front wheel cuts, clearance and turning radius.

Unmatched comfort

Granite's all-new interiors are purpose-built and designed to keep drivers comfortable all shift long.

Axle configurations

Available in axle forward and axle back models with single, tandem and tri-drive configurations, Granite can be customized with multiple steering, drive and auxiliary axle combinations.

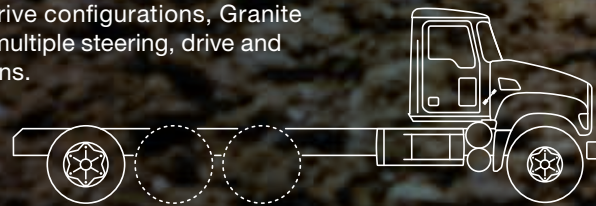

Granite[®] Mixer

Mack[®] Granite mixers haul more concrete and keep America moving forward.

Weight savings

Weight-saving design and productivity-boosting components make for greater payload.

Simple installation

The body-ready electrical system cuts down on installation time and reduces costs.

Safety

Our Roll Stability Advantage and exceptional brakes enhance control over any terrain. Plus, we offer outstanding visibility to make sure your Mack meets no surprises on site.



Granite[®] Dump

Mack[®] Granite dump trucks shrug off the abuse of the jobsite so you can focus on your job.

Weight savings

Lightweight components and options such as lift axles help maximize hauling capacity and productivity.

“D”-shaped fuel tank

Options like the “D”-shaped fuel tank save you critical weight and space.

Custom frame rails

No matter what your load, Mack offers customizable frame rails to fit your construction needs.



Granite[®] MHD

Get nothing but rock-solid performance out of the Mack[®] Granite MHD. Ideally configured for shorter runs and lighter-duty cycles, this truck cuts weight without sacrificing durability.

9-liter engine

MHD's lightweight, dependable 9-liter Cummins L9 engine reaches 350 HP with a maximum torque rating of 1,150 lb.-ft.

Cornerstone[™] chassis

Built with the MHD in mind, the 7mm steel alloy frame rail is durable and reliable.

"D"-shaped fuel tank

This unique design allows you to hold more fuel without sacrificing space.

Axle configurations

Granite MHD is available in axle forward and axle back models, with single and tandem axle configurations.

Unimax[®] axles

Featuring exceptional wheel cuts, front-end swing clearance and turning radius, the 16,000-lb. axle capacity is a great choice for the MHD.

Galvanized steel cab

Mounted on airbags and shocks, our galvanized steel cab soaks up the rough stuff, so you ride in comfort.

Premium interiors

Tough materials and an ergonomic design help drivers take on any task in comfort.

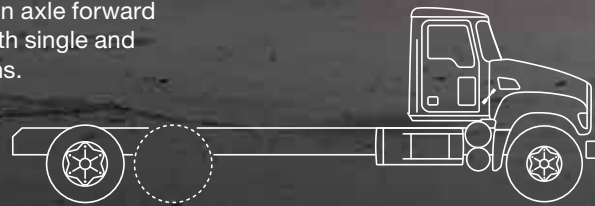

Pinnacle™

The Mack® Pinnacle is designed with the comfort drivers need and the durability the road demands. Whether the haul is off-road or cross-country, Pinnacle is purpose-built to keep drivers comfortable and driving strong.

Advantage™ chassis

Pinnacle's Advantage chassis is configured for clean wheel cuts and easy maneuverability. The lighter, stronger frame rails support heavy loads, even on challenging terrain.

Suspension choices

With several options available, the Pinnacle can be equipped with the suspension that fits your needs—from high-articulation mechanical suspensions such as the Mack *mRIDE™* or Camelback to durable, lightweight air suspensions like the Mack AL.

Highly customizable

No matter your haul, Mack makes it easy to optimize your Pinnacle for the job.

Ground clearance

The axle-forward position provides better clearance for when the Pinnacle needs to go off-highway and over bumpy terrain.

Cab configurations

In Day Cab or Sleeper, the Pinnacle has the comfort and strength to keep drivers going strong until the job is done.



Day Cab



48-inch
Flat Top Sleeper

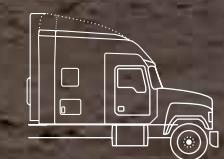

70-inch
Stand Up Sleeper

All-new interiors.

Redesigned interiors in the legendary Mack[®] Granite[®] and Pinnacle[™] make our construction models more comfortable and driver friendly than ever before. So your team can get more done and finish the day as strong as they started.

Customize your Mack.



DASH AND INTERIOR TRIM PACKAGES



Standard

-  Gunmetal dash
-  Charcoal door trim
-  Steel Gray interior trim
-  Interior trim also available in Sierra Tan (Day Cab only)

Premium

-  Aluminum dash and door trim
-  Steel Gray interior trim
-  Interior trim also available in Sierra Tan (Day Cab only)

SEATS



Standard

Durable vinyl construction for low maintenance and easy cleaning.



Premium

Choose from vinyl construction with cloth inserts or Ultraleather[®] for the right combination of style and performance.

STEERING WHEELS



Standard

Urethane foam rim
Gunmetal spokes
All controls located on the D-panel
Also available with steering wheel controls and Satin Aluminum spokes



Premium

Leather-wrapped rim
Leather horn pad
Satin Aluminum spokes
Steering wheel controls



Flat-Bottom Steering Wheel

An industry first, allowing more belly room and clearance for entry or exit.



Mack-Exclusive Seats

Designed in partnership with Sears Seating to improve driver comfort.



Power Window, Lock and Mirror Controls

Provide more comfort and control than manual windows.



Rocker Switches

New larger, robust rocker switches are laser etched to be readable for life.

Additional options available; contact your Mack dealer for more information.

TerraPro[®]

Meet the truck designed for best-in-industry packaging for concrete boom pumps. It has up to 505 HP with great ergonomics and visibility.

MP[®] engine series

Combine fuel-efficient engines with low-end torque, and you get the MP Engine Series: the heartbeat of the Mack[®] TerraPro.

mDRIVE[™] HD

A heavy-duty automated manual transmission for concrete pump applications maximizes performance and fuel economy, while reducing driver fatigue. And it has an extended range of gears, including 13- and 14-speed creeper gears.

Durable chassis

Built to adapt to customer needs, TerraPro's chassis is optimized to tackle big-time construction jobs.

ClearTech[™] emissions control system

Mack delivers ultra-low emissions while maximizing space on chassis and frame.

Exceptional visibility

The large windshield, low-profile dash, side and rear mirrors and ergonomic seat position provide drivers with superior visibility.

Axle configurations

Available in single, tandem and tri-drive configurations, TerraPro can be customized with multiple steering, drive and auxiliary axle combinations.



Integrated powertrain? Try integrated everything.

It's one thing to invent the integrated powertrain. We did that more than 100 years ago, and today our revolutionary powertrain sets the gold standard.



Mack® MP® Engines

With horsepower, torque and great fuel economy, Mack MP engines power through the job.

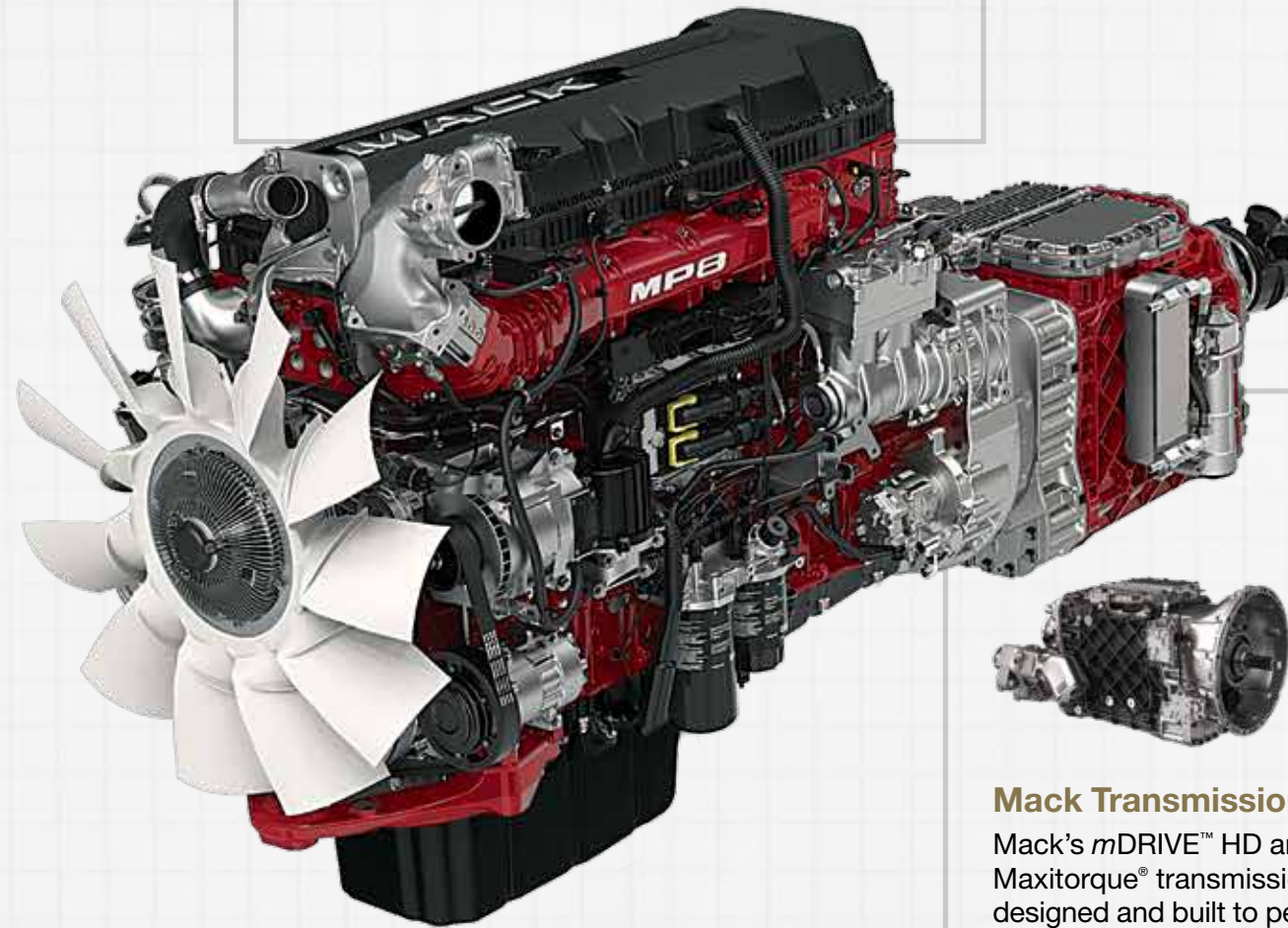

Mack Transmissions

Mack's *mDRIVE™* HD and T300 Maxitorque® transmissions are designed and built to perform at the highest level in the most demanding conditions, just like the rest of the truck.



Mack® Axles

Mack axles and carriers are engineered to handle heavy hauls and the rigors of the jobsite.



Mack Suspensions

We've engineered Mack suspensions for reliability and outstanding performance, no matter where they go. Which, with a Mack truck, can be almost anywhere.



Now, we've gone ahead and integrated the whole truck operating experience. From financing to service to 24/7 support, Mack has taken uptime and productivity to a whole new level.



Mack Electronics

Featuring proven V-MAC® IV electronics, Mack makes it easier to work the way you want. Effortlessly manage your truck and engine, so you save on fuel and boost your bottom line.

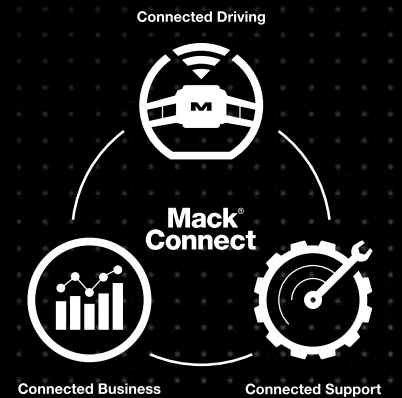

Mack Connect

Mack's exclusive uptime and productivity solution combines intelligent software, predictive analytics, driver assist technologies and more to help you keep your business moving forward.

MackTrucks.com/MackConnect

Tough enough for the roughest jobs.

Armed with axles and suspensions built for the load, and the transmission that won't weigh you down, you're up for any challenge.

MACK® CAMELBACK

The Camelback suspension is built with increased stability to handle the stress of off-road and severe-duty trucking. This tried-and-true suspension allows for better steering and reduced tire wear. Camelback is available from 38,000- to 65,000-lb. ratings.

MACK AXLES

Proprietary Mack axles provide greater articulation on the most demanding construction sites. Our C180/181 top-mounted carriers deliver more efficient power to the wheels with less parasitic loss than with front-mounted carriers.

MACK T300 MAXITORQUE® TRANSMISSION

Available on TerraPro® and Pinnacle™ construction models, the powerful Maxitorque transmission offers options from 9 to 18 speeds. It features the industry's only triple-countershaft design and easy shifting for increased durability and smooth gear transitions. Maxitorque has more PTO positions than any other transmission to help you master the demands of the job.

ALLISON® AUTOMATIC TRANSMISSION

All Mack construction models are available with a choice of Allison automatic transmissions, making it simple to match your application to the right transmission for the job.



Mack® MP® engine series.

Mack's engine enhancements reduce weight and increase efficiency so you can haul more, and use less fuel do to it.

COMMON RAIL FUEL SYSTEM

Delivers pre- and post-combustion injections for more power and efficiency.

WAVE PISTON

Creates more complete combustion to increase fuel economy and reduce soot.

LESS MAINTENANCE

Two-piece valve cover, shimless rockers and simplified low-pressure fuel system improve reliability, serviceability and efficiency over the life of your engine.



MP®7

The 11-liter MP®7 engine is built for optimal fuel efficiency. Available on all Mack construction models, this lightweight engine has evolved to run even cleaner. It emits less CO₂ than ever before while maintaining a HP range from 325 to 425 HP and torque ratings from 1,260-1,560 lb.-ft.



MP®8

The MP®8 blends fuel economy, power and increased uptime. Offered on all Mack construction models, the latest evolution of this 13-liter engine is designed to meet even stricter emissions standards and deliver optimal HP range from 415 to 505 HP, with torque from 1,660-1,860 lb.-ft.



MACK® CLARTECH™ ONE

Mack knows emissions control systems, so we took ours one step further to optimize the overall package; and the result is ClearTech One. This new and improved exhaust aftertreatment system (EATS) is lighter and takes up less space, which saves fuel and money while improving flexibility.

mDRIVE™ HD

Automatically shift your thinking.



This heavy-duty automated manual transmission is available in the Mack® Granite® and TerraPro®. It maximizes performance and fuel economy while reducing driver fatigue. With an extended range of gears, including 13- and 14-speed creeper gears, Mack's mDRIVE™ HD uses intelligent software and engine integration to automatically select the best gear and shift with speed and precision for an easier ride.

LIGHTER THAN THE COMPETITION

Even though the mDRIVE HD™ is built tough, it won't weigh you down. This transmission is hundreds of pounds less than competitors, so you can ditch the dead weight and increase your payload. With Mack®, it takes less to get more done.

ONE-STOP SERVICE

Because mDRIVE HD is a Mack transmission, it's serviced in Mack's industry-leading, coast-to-coast dealer network and supported by our exclusive uptime solution, Mack Connect. Now drivers can forget the hassle of third-party repairs and get back to the job where they belong.

COMPLETE INTEGRATION

As part of Mack's legendary integrated powertrain, mDRIVE HD works seamlessly with Mack engines and axles for improved efficiency, increased uptime and lower cost. Because when all the pieces perform together, everything else falls into place.

INCREASED PRODUCTIVITY

The mDRIVE HD is automated, so it's easier to work than traditional manual transmissions. Because drivers don't have to worry about shifting gears, they're more rested and ready to finish the job with increased focus and productivity.



With Mack® Connect, it's uptime all the time.

Mack's exclusive uptime and productivity solution, Mack Connect, combines intelligent software, predictive analytics, driver assist technologies and more to help you get the job done.



CONNECTED DRIVING

The trucking business is all about making margins and driving efficiency. Get the most out of your trucks and your drivers with built-in fuel management and driver assist technologies like Mack® Predictive Cruise.



CONNECTED BUSINESS

To succeed in the modern trucking industry you need to run a modern trucking company. Drive profitability and gain insights at every turn with Mack's fleet management systems. Our open platform sends vehicle data directly to your own fleet management software for analysis, so you're not locked into a proprietary system.



CONNECTED SUPPORT

Your trucks are only profitable when they're on the road and on the job. Maximize your uptime with intelligent maintenance systems and time-saving repair processes.

Stay on the job.

Stay on task and on time with Mack's award-winning combination of vehicle telematics, live support personnel, fleet management services and an expansive network of Certified Uptime Centers and nearly 600 authorized dealers.

800-866-1177

**MACK® ONECALL®
SUPPORT LINE**

MACK ONECALL

Anywhere in the United States and Canada, Mack OneCall provides around-the-clock roadside assistance and customer support from a team of highly trained uptime experts.

GUARDDOG® CONNECT

Our telematics platform automatically monitors your truck for potential issues and starts the support, repair and scheduling process sooner—all while you're still on the job.

CERTIFIED UPTIME CENTERS

Dealers identify quick fixes and put them in the fast lane for completion, while giving larger repairs the attention they need and putting you back on the road faster.

CONCRETE PUMP HOTLINE

Exclusively for concrete pump customers, our 24/7 Concrete Pump Support Hotline gives you direct access to specialized support.

877-893-3007

WHERE'S MY CONCRETE

Real-time data for dispatch, transparency for customers, and critical analytics to improve operations.

Built tough from the very beginning.

Trucks shouldn't become tough; they should be born tough. That's why Mack is expanding its century-old commitment to support. We offer body builders direct access to the answers they need to engineer dependable trucks from the ground up. Mack's body builder support group is designed to take integration to the next level and increase collaboration between body builders, dealers and customers from the time you order your truck to the moment it arrives.

And once your truck is built, we continue to provide the support you need to conquer any site with Mack® Connect, Mack's uptime and productivity solution. Backed by Mack, you'll attack every job with confidence.



Body builder support for any application.



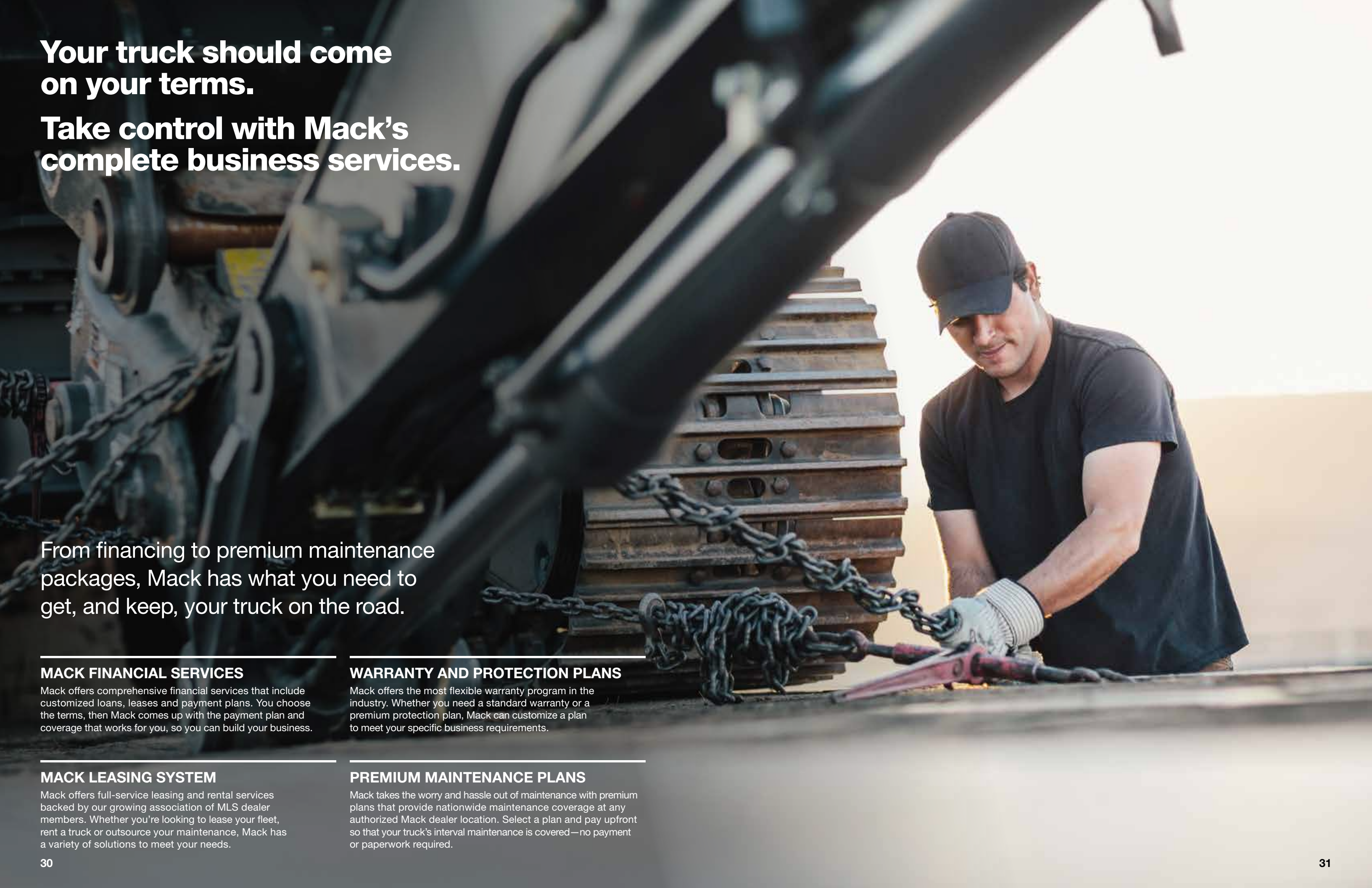

**Your truck should come
on your terms.**

**Take control with Mack's
complete business services.**

From financing to premium maintenance packages, Mack has what you need to get, and keep, your truck on the road.

MACK FINANCIAL SERVICES

Mack offers comprehensive financial services that include customized loans, leases and payment plans. You choose the terms, then Mack comes up with the payment plan and coverage that works for you, so you can build your business.

MACK LEASING SYSTEM

Mack offers full-service leasing and rental services backed by our growing association of MLS dealer members. Whether you're looking to lease your fleet, rent a truck or outsource your maintenance, Mack has a variety of solutions to meet your needs.

WARRANTY AND PROTECTION PLANS

Mack offers the most flexible warranty program in the industry. Whether you need a standard warranty or a premium protection plan, Mack can customize a plan to meet your specific business requirements.

PREMIUM MAINTENANCE PLANS

Mack takes the worry and hassle out of maintenance with premium plans that provide nationwide maintenance coverage at any authorized Mack dealer location. Select a plan and pay upfront so that your truck's interval maintenance is covered—no payment or paperwork required.

**Let's
Build.**

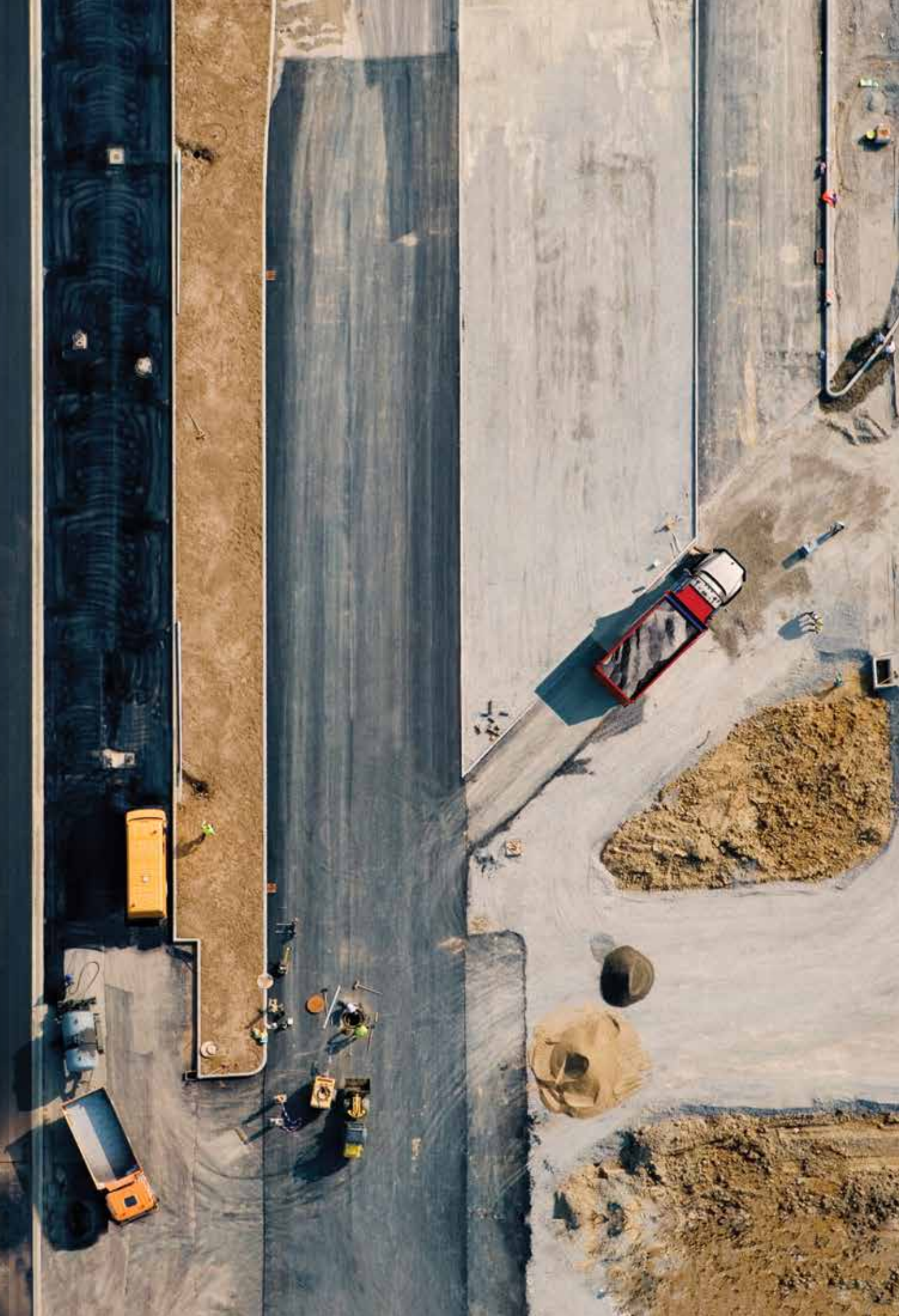





1-800-922-MACK
MackTrucks.com

©2019 Mack Trucks, Inc.

 facebook.com/MackTrucks

 twitter.com/MackTrucks

 youtube.com/MackTrucks

 linkedin.com/company/Mack-Trucks

 instagram.com/MackTrucks